

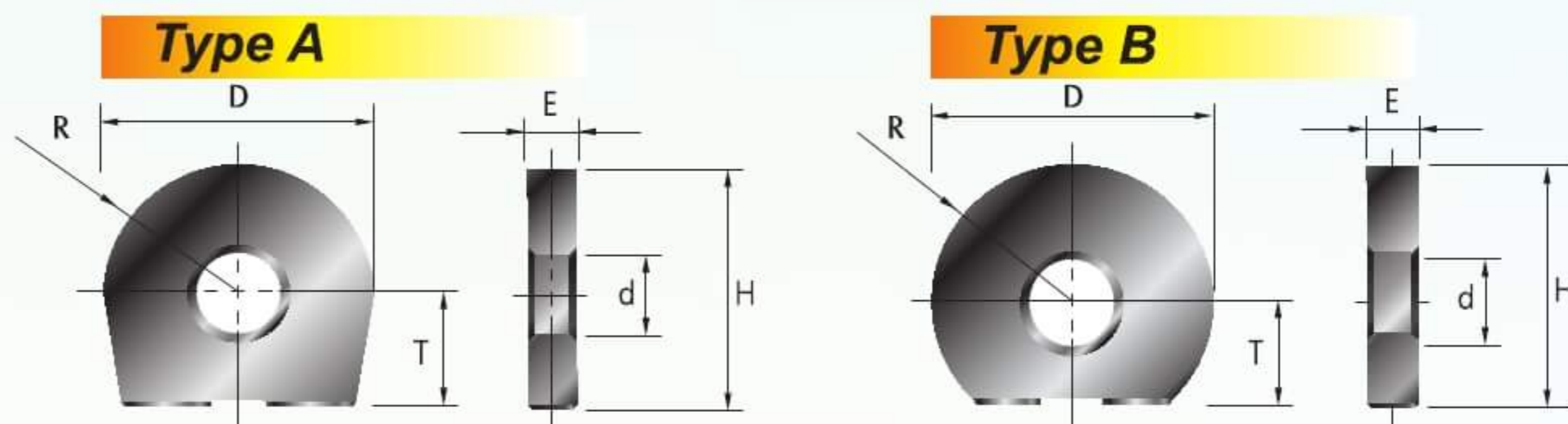

捨棄式刀片

Insert
muzeelf

WTB Series



● 不適用於含碳量高的鋼材，例：中碳鋼 (S45C//1.1210)
 Note: Not suitable for high carbon steel cutting, e.g. medium-carbon steel (S45C//1.1210).

型號 Type	尺寸規格 Dimension						Type	塗層 Coating
	R	D	d	T	E	H		
WTB010	R 5	10	4	5	2.5	11.5	A	T2
WTB012	R 6	12	5	6	2.5	12		
WTB016	R 8	16	5	6	3	14	B	
WTB020	R 10	20	5	6	3	16		
WTB025	R 12.5	25	6	9	4	21.5		
WTB030	R 15	30	8	10	5	25		
WTB032	R 16	32	8	10	5	26		

Unit:mm

WGB Series

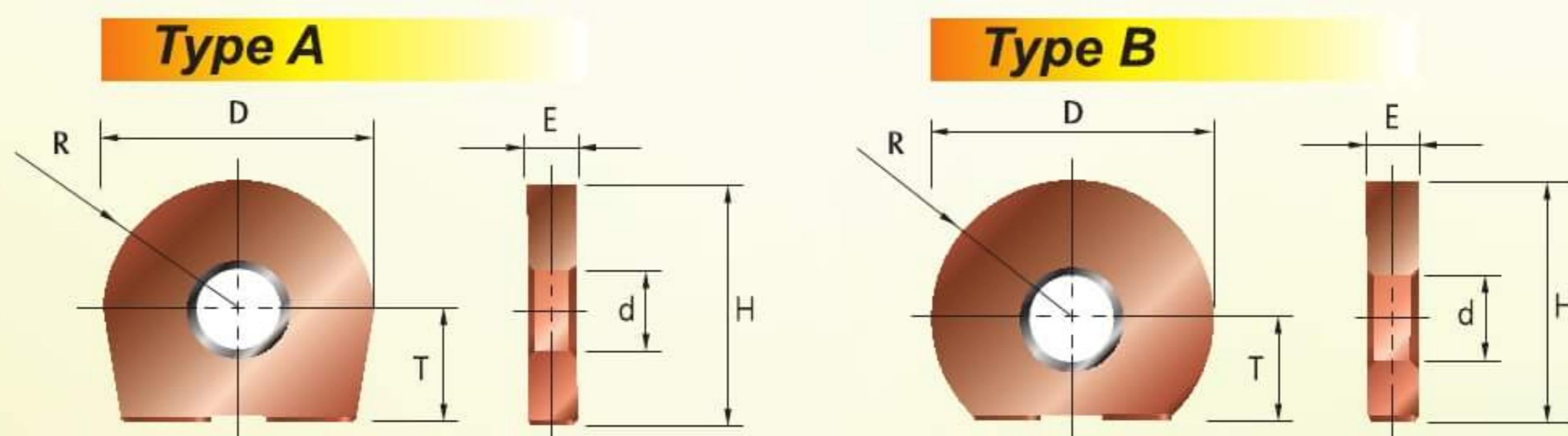

● 適用切削一般的鋼材
 Note: Good for all general steel material cutting.

型號 Type	尺寸規格 Dimension						Type	塗層 Coating
	R	D	d	T	E	H		
WGB010	R 5	10	4	5	2.5	11.5	A	G7
WGB012	R 6	12	5	6	2.5	12		
WGB016	R 8	16	5	6	3	14	B	
WGB020	R 10	20	5	6	3	16		
WGB025	R 12.5	25	6	9	4	21.5		
WGB030	R 15	30	8	10	5	25		
WGB032	R 16	32	8	10	5	26		



Unit:mm



測試報告及磨耗量比較 Processing Data & Comparison of tool wear

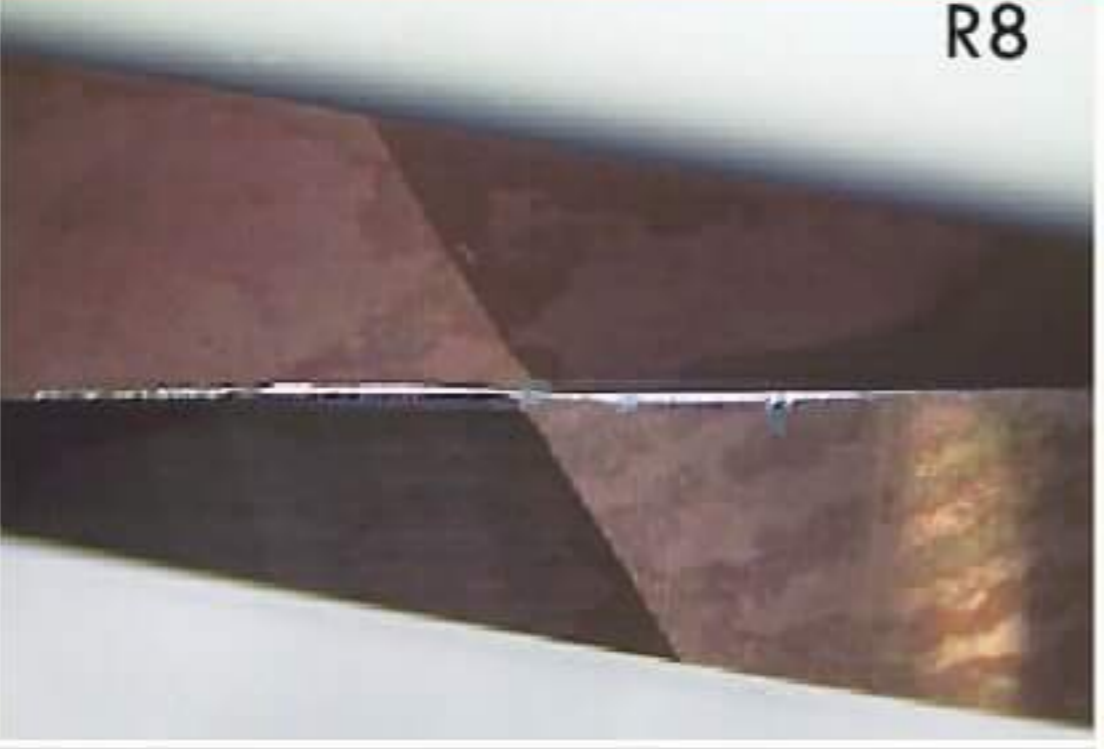
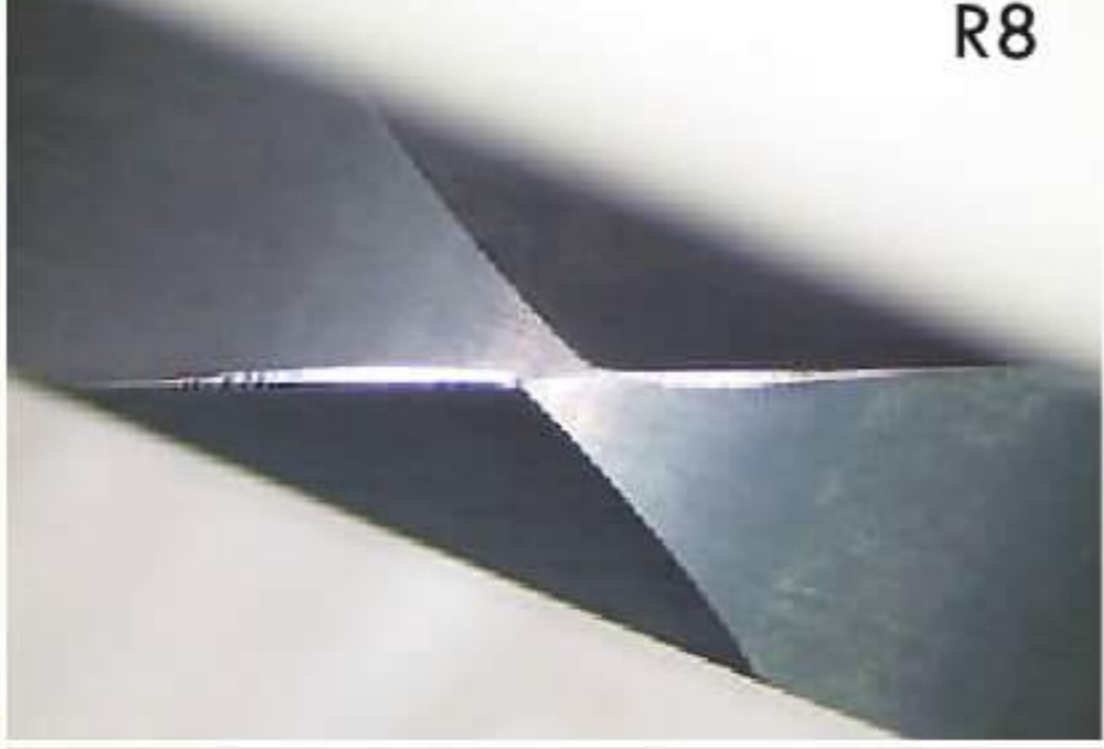

中碳鋼 JIS : S50C / DIN : 1.1206 (HRc18)

使用刀具 Tool	刀具伸長量 Extension Length (mm)	切削速度 Cutting Speed (m/min)	迴轉速度 Speed (min ⁻¹)	進給速度 Feed (mm/min)	加工深度 Depth of Cut (aa)	加工寬度 Width of Cut (ap)	加工方式 Milling Type	冷卻方式 Coolant type	總測試加工時間 Total Machining Time (min)	加工長度 Milling Length (m)
R8	100	200	4000	2000	0.15	0.3	3D銑 3D Milling	水溶性切削液 Water Soluble	200	300

使用刀具 Tool	DHF WGB016 <small>NEW</small>	A公司 Competitor A	B公司 Competitor B
切削後刀具 Cutting edge after milling	 R8	 R8	 R8
磨耗量(mm) Wear amount	0.06	0.135	0.19

塑膠(料)模具鋼 Plastic Mould Steel JIS : P20 / DIN : 1.2311 (HRc32)

使用刀具 Tool	刀具伸長量 Extension Length (mm)	切削速度 Cutting Speed (m/min)	迴轉速度 Speed (min ⁻¹)	進給速度 Feed (mm/min)	加工深度 Depth of Cut (aa)	加工寬度 Width of Cut (ap)	加工方式 Milling Type	冷卻方式 Coolant type	總測試加工時間 Total Machining Time (min)	加工長度 Milling Length (m)
R8	100	225	4500	2000	0.15	0.3	3D銑 3D Milling	水溶性切削液 Water Soluble	250	350

使用刀具 Tool	DHF WGB016 <small>NEW</small>	A公司 Competitor A	B公司 Competitor B
切削後刀具 Cutting edge after milling	 R8	 R8	 R8
磨耗量(mm) Wear amount	0.07	0.08	0.12



德信發企業有限公司

DHF Precision Tool Co., Ltd.

營運總部

台灣台中市南屯區大墩六街425號
No.425, Da Dun 6th St., Nantun District., Taichung
40867 Taiwan
TEL : 886-4-23815088 FAX : 886-4-23814488
<http://www.endmill.com.tw>
E-mail : dhf@endmill.com.tw

分公司

Italy / Pordenone

DHF Italia Srl <http://www.dhfitalia.it>

Turkey / Istanbul

DHF Sert Kesici Takimlar

Poland / Katowice

DHF Polska Sp z o.o.

China / Shanghai

上海市徐匯區嘉匯國際廣場
TEL : 021-64564958 FAX : 021-64564968

China / GuangDong

東莞市虎門鎮索菲特東方時代廣場
TEL : 0769-85115970 FAX : 0769-85240930